



Pump Division

LNN

***Axially Split,
Double Suction,
Single Stage
Pump***



Pump Supplier To The World

Flowserve is the driving force in the global industrial pump marketplace. No other pump company in the world has the depth or breadth of expertise in the successful application of pre-engineered, engineered and special purpose pumps and systems.

Pumping Solutions

Flowserve is providing pumping solutions which permit customers to continuously improve productivity, profitability and pumping system reliability.

Market Focused Customer Support

Product and industry specialists develop effective proposals and solutions directed toward market and customer preferences. They offer technical advice and assistance throughout each stage of the product life cycle, beginning with the inquiry.



Dynamic Technologies

Flowserve is without peer in the development and application of pump technology, including:

- Hydraulic engineering
- Mechanical design
- Materials science
- Intelligent pumping
- Manufacturing technology

Broad Product Lines

Flowserve offers a wide range of complementary pump types, from pre-engineered pump types, to highly engineered and special purpose pumps and systems. Pumps are built to recognized global standards and customer specifications.

Pump designs include:

- Single stage process
- Between bearing single stage
- Between bearing multistage
- Vertical
- Submersible motor
- Rotary
- Reciprocating
- Nuclear
- Specialty

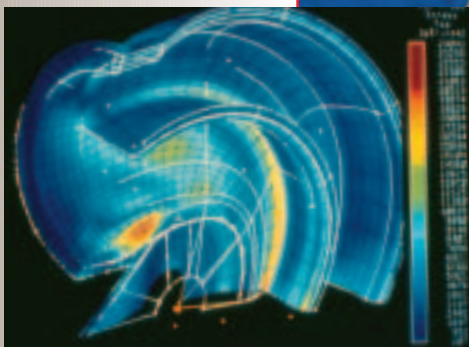
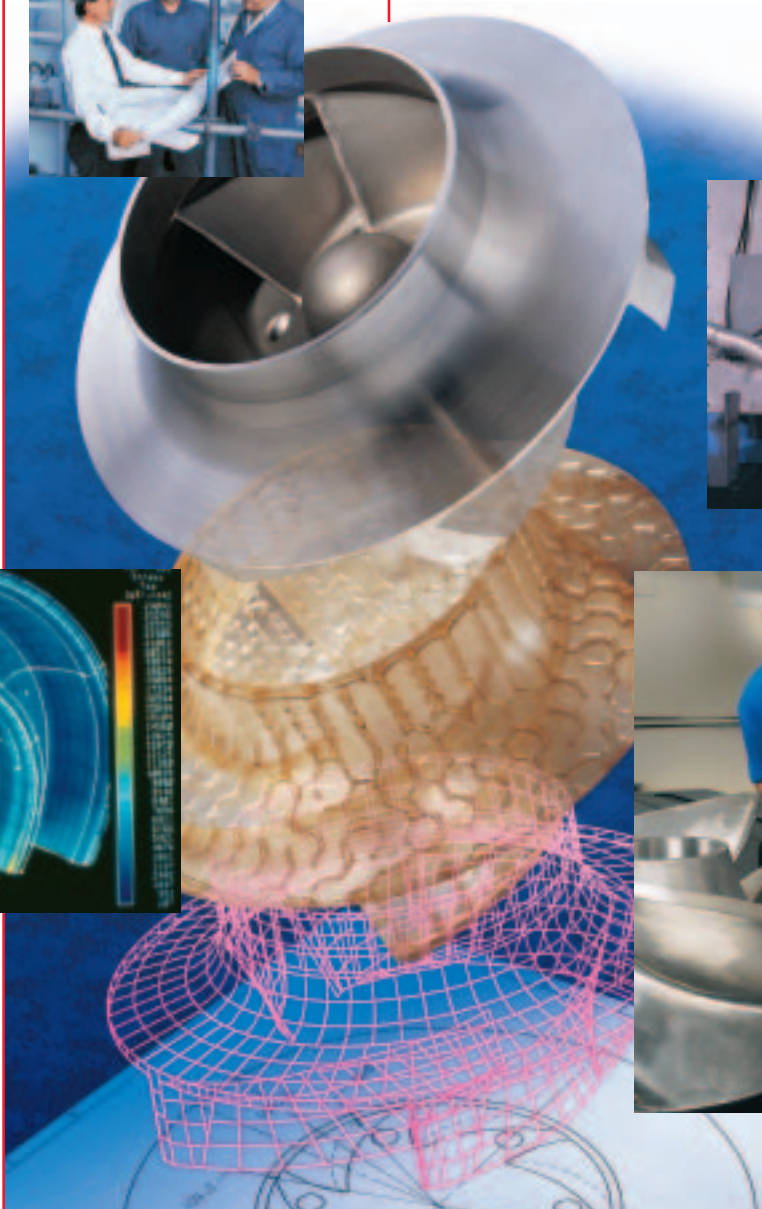

LNN
Family of
Horizontal Split
Case Pumps
For Application
Versatility

Broad Hydraulic Coverage
 Flowserve's model LNN and associated double suction axially split pumps are available with 145 impeller and volute combinations. As a result Flowserve provides the most options for highest efficiency operation in all water applications.

User industry standards, specifications and preferences have been incorporated in the rotating element design with particular emphasis on ease of maintenance.

The integrated design philosophy provides optimum parts interchangeability of bearing housings, seal chambers, wear rings and shaft sleeves.

Typical Applications

- Water cooling
 - Cooling tower
 - Circulating
- High and low water lift
- Raw water transfer
- Cargo loading and unloading
- Heating, ventilation and air conditioning
- Low pressure pipeline
- Fire protection
- Irrigation
- Crude oil transfer
- Seawater circulation
- Marine services

Complementary Pump Designs

Depending upon application requirements, Flowserve can also provide these design pumps:

- Vertical turbine
- Horizontal, centerline mounted
- Vertical double suction

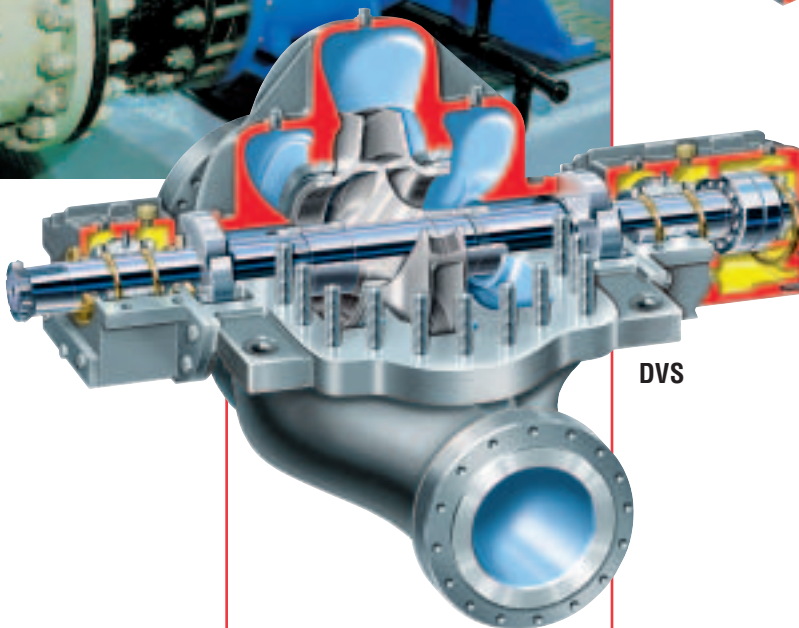
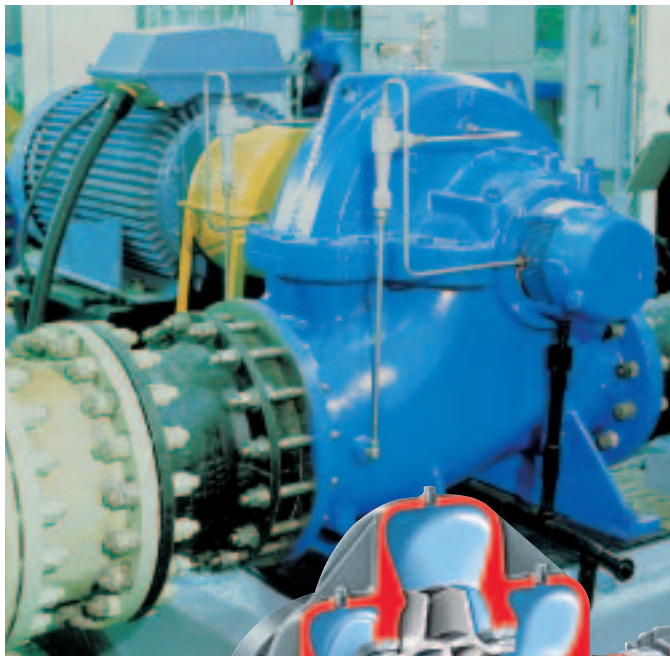

DVS

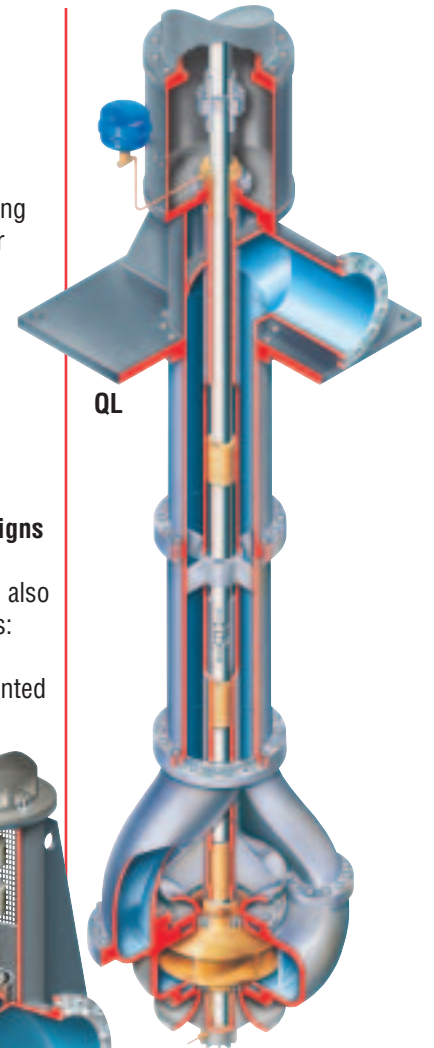

QL

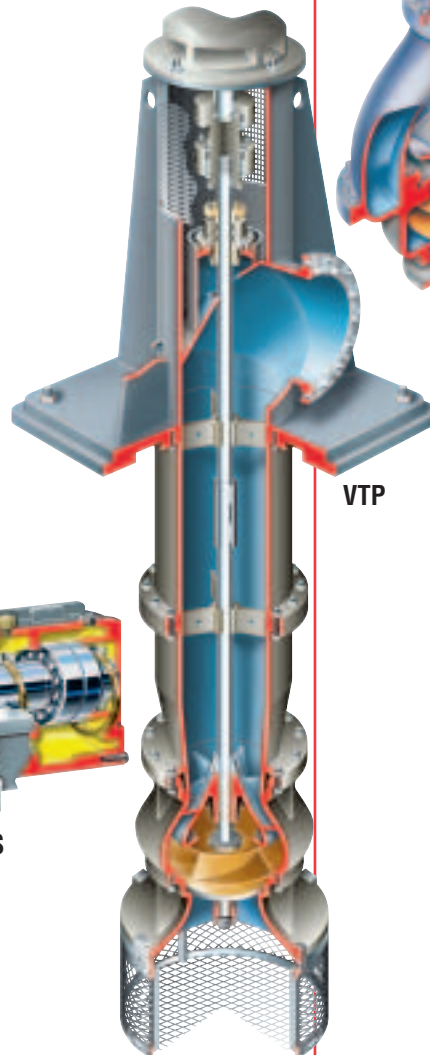

VTP

LNN
**Axially Split,
 Double Suction,
 Single Stage
 Pump**

The LNN family of pumps is the outcome of many years' experience in the design and manufacture of axially split casing pumps. State of the art pump design technology from Flowserve has resulted in superior pumps combining quiet operation, low NPSH requirements and high operating efficiency.

Operating Parameters

- Flows to 51 000 m³/h (225 000 gpm)
- Heads to 300 m (985 ft)
- Sizes 125 mm (5 in) to 1200 mm (48 in)
- Pressures to 30 bar (435 psi)
- Temperatures to 150° C (300° F)

Pump Casing Features

- Double volute
- Suction and discharge flanges in ANSI, DIN or ISO configurations
- Heavy duty integral mounting feet
- Upper case lifting lugs

Seal Chamber Features

- Independent cast housing for packing or mechanical seal
- Four bolt gland attachment for mechanically sealed designs
- Easy retrofit capability for conversion from packing to mechanical seal

Bearing Options

- Antifriction ball bearings standard
- Double row, angular contact thrust bearings option
- Sleeve radial and hydrodynamic axial thrust bearings option

Bearing Sealing and Lubrication Options

- Grease lubrication standard
- Oil bath or oil mist lubrication option
- Bearing housing protection by "V" ring seals or optional labyrinth seals

Shaft and Shaft Sleeve Features

- Steel or duplex stainless steel shaft material
- Outside mounted and set screw locked shaft nuts
- Precision ground, key driven, locked and "O" ring gasketed shaft sleeves

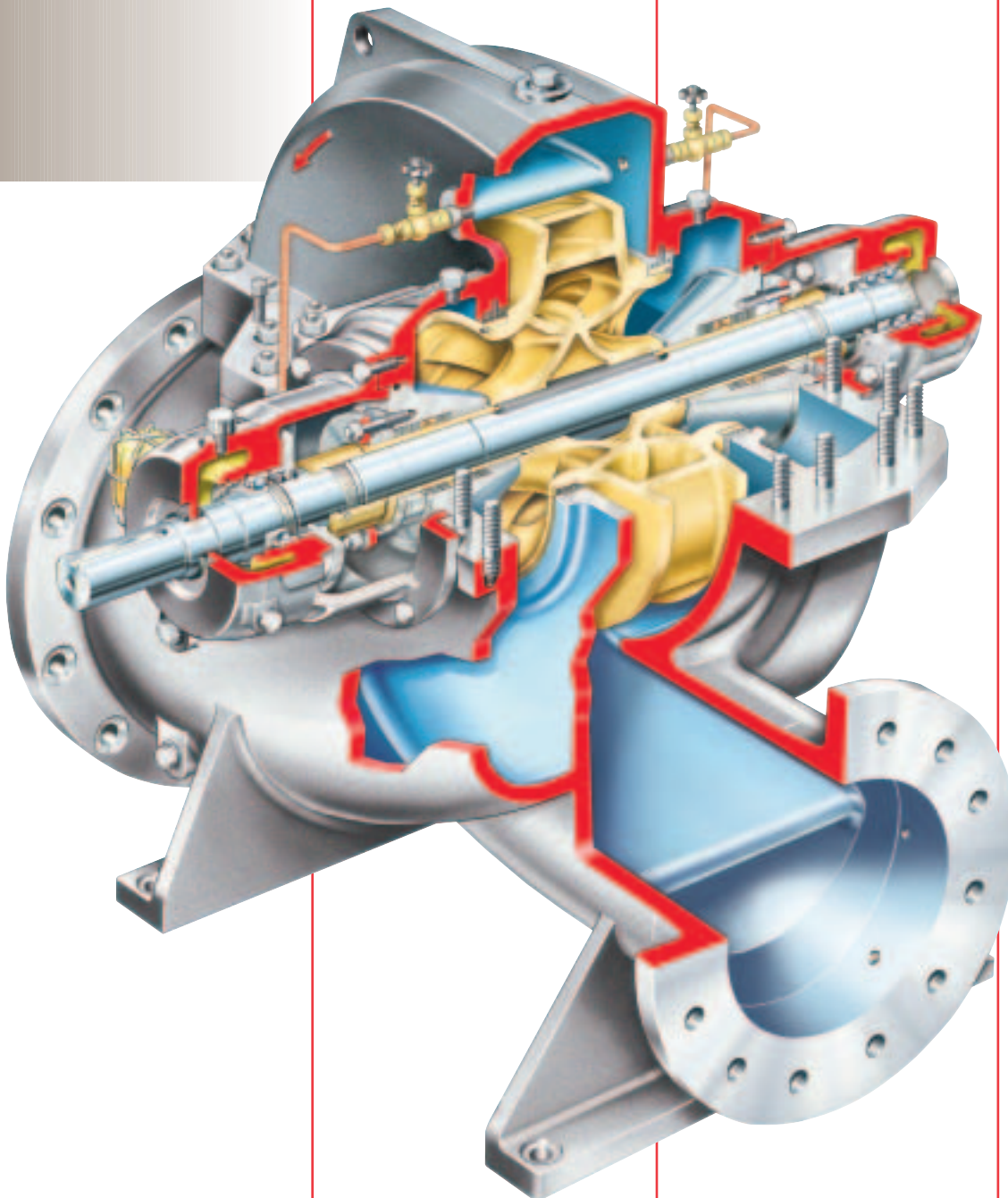

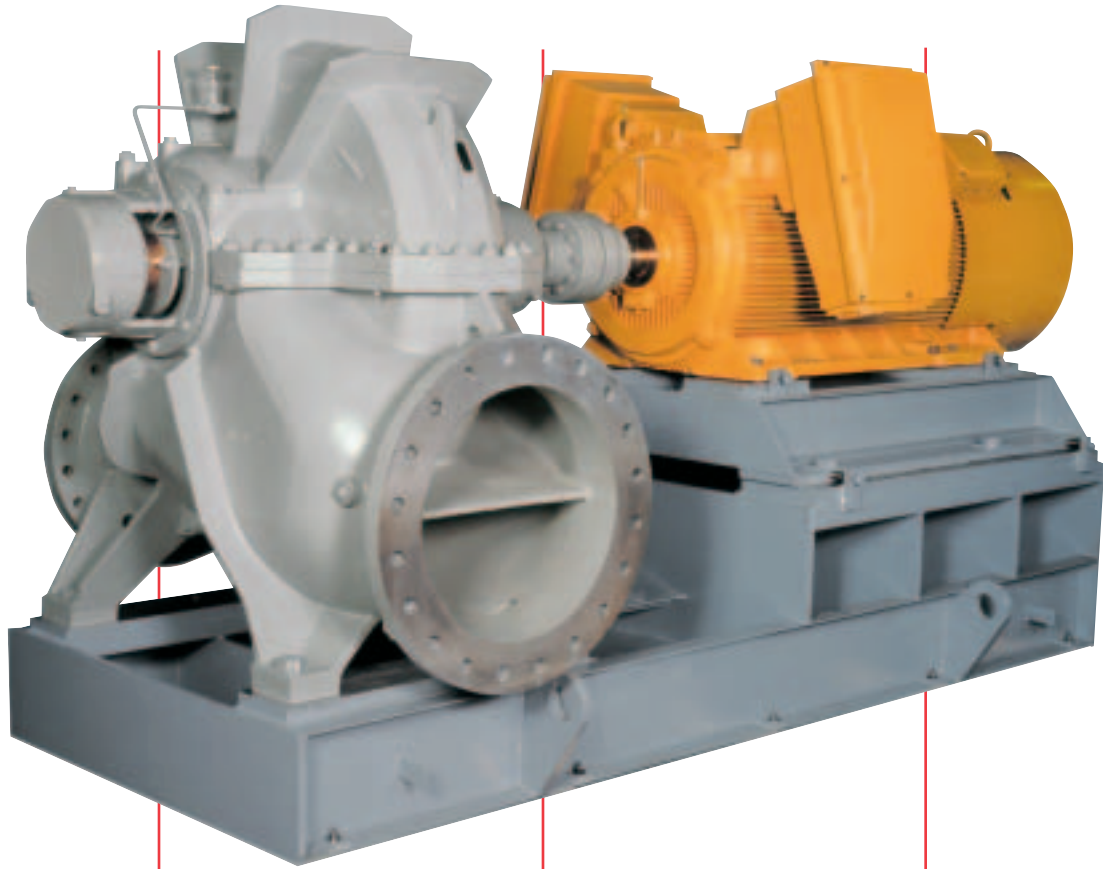

Bearing Housings with 360° attachment and unique fastening to upper and lower casings provide superior bearing stability and shaft support. Perfect shaft alignment is assured by a full register fit to the casing. Bearing housings and stuffing boxes can be easily removed and reinstalled.

Casing Materials available to suit service conditions include cast iron, ductile iron, ductile Ni-Resist D2, bronze, nickel aluminum bronze, carbon steel, 316 stainless steel and duplex stainless steel.

Casing Design with suction and discharge flanges in the lower half, allows access to the rotating element without disturbing piping or driver. Upper casing does not have to be opened to remove and replace bearings, packing, mechanical seals, sleeves and sleeve nuts.

Precision Cast Impeller assures achievement of maximum pump efficiency. Impellers are dynamically balanced to ISO 1940 tolerances. Multiple impeller designs exist for each casing to give maximum flexibility for upgrading pump performance to meet future service conditions.

Shaft is conservatively designed to minimize deflection and reduce maintenance costs caused by wear.

Wear Rings, positively locked by radial pins, are standard for casing protection. Optional for impeller protection, wear rings are shrinkfit and pinned securely.

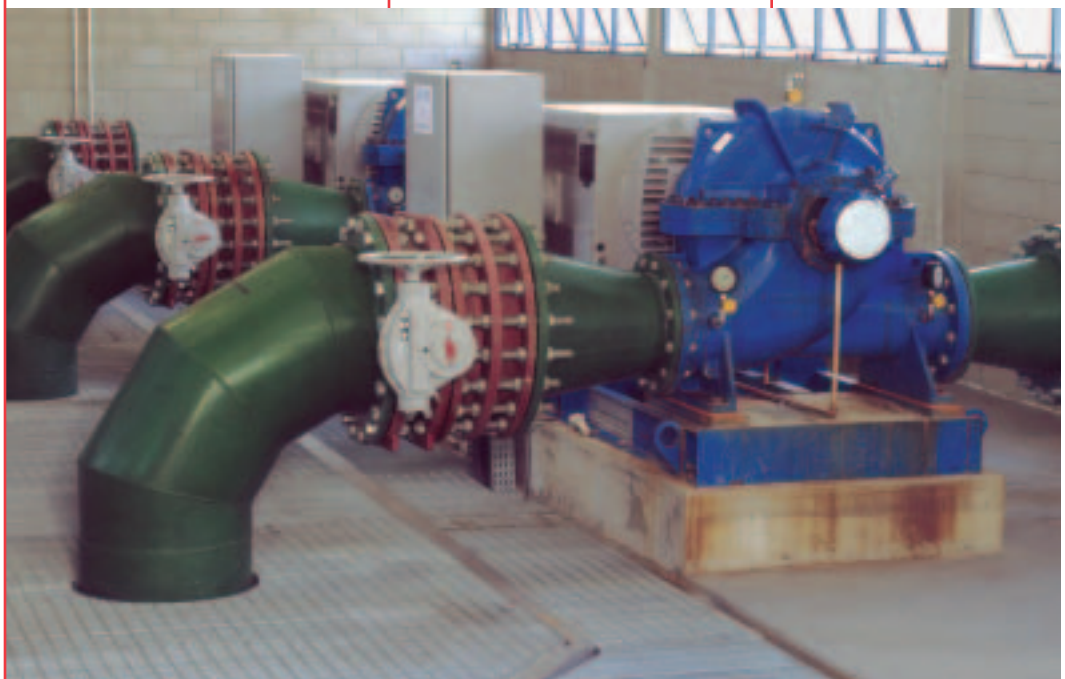

Options and Technical Data



LNNV

Mounting Options

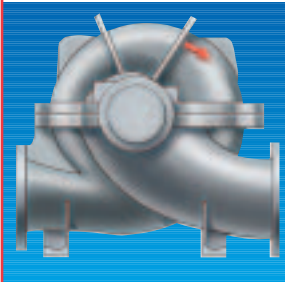

LNN
Horizontal mounting with side suction and side discharge



LNNV
Vertical mounting with suction and discharge in-line

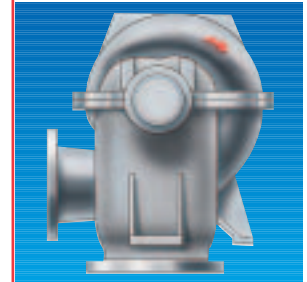

LNNC
Horizontal mounting with bottom suction and side discharge

LNN Range Chart

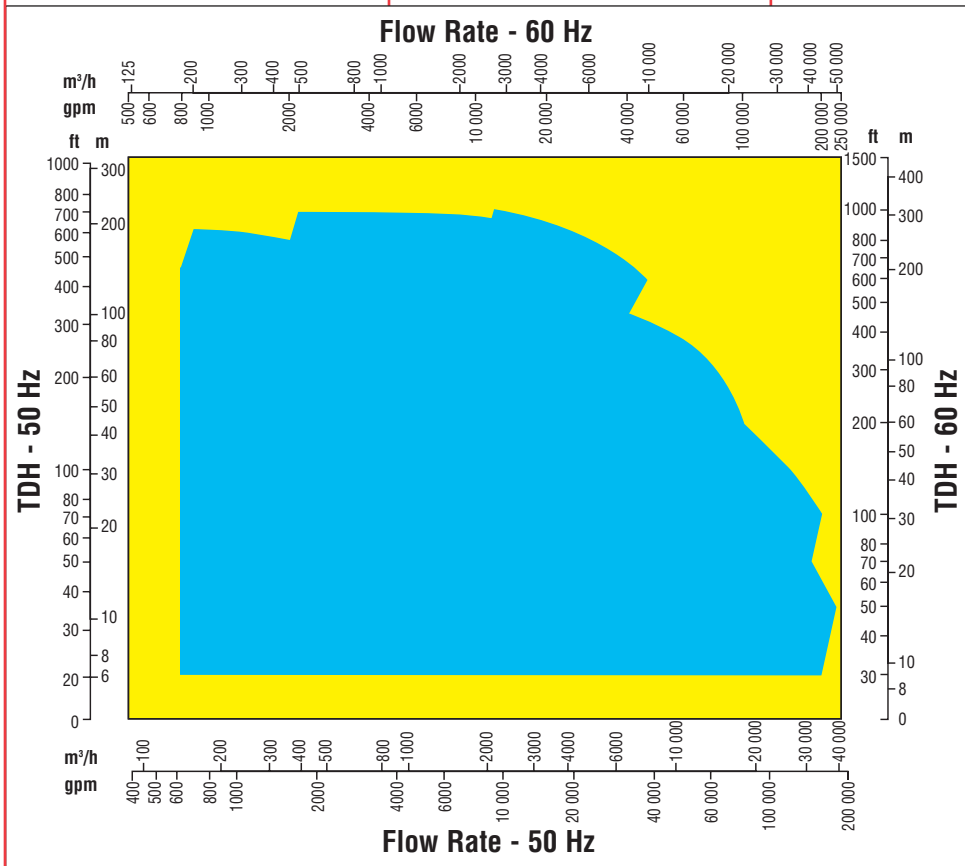

Global Service and Technical Support

Advanced Technologies

Few if any pump companies can match Flowserve's capabilities in hydraulic and mechanical design or in materials engineering. These capabilities include:

- Computational fluid dynamics
- Flow visualization
- Cavitation studies
- Efficiency optimization
- Finite element analysis
- Rapid prototyping
- Captive high nickel alloy and light reactive alloy foundries
- Non-metallic materials processing and manufacturing

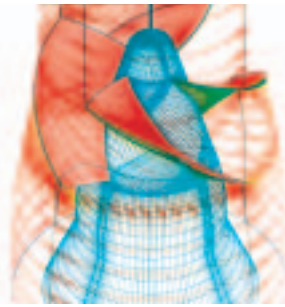

Service and Repair Group

Flowserve's Service and Repair Group is dedicated to maximizing equipment performance and reliability-centered maintenance programs. Pump related services include:

- Startup and commissioning
- Diagnostics and prognostics
- Routine and repair maintenance
- ANSI and ISO power end exchange program
- Re-rates, upgrades and retrofits
- Spare parts inventory and management programs
- Training

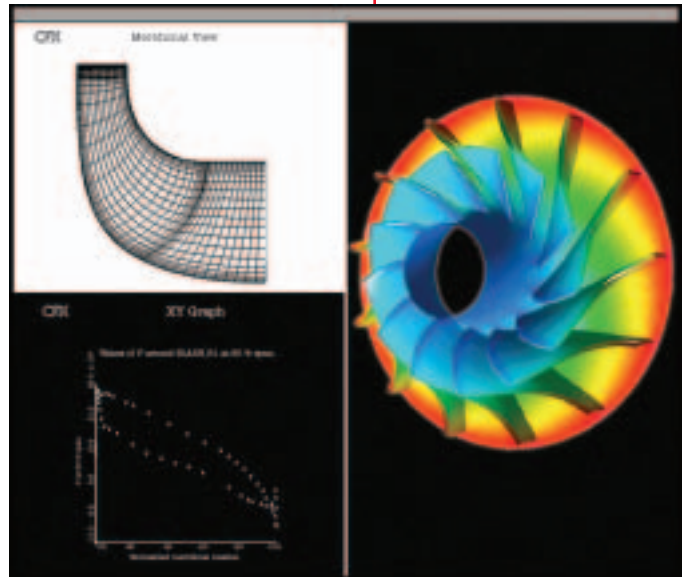

Pump Improvement Engineering Services

Flowserve is committed to helping customers obtain the best possible return on their pump equipment investment. Engineering assistance and technological solutions for pumping problems are readily available.

These services include:

- Field performance testing
- Vibration analysis
- Design analysis and root-cause problem solving
- Material improvements
- Pump and system audit
- Advanced technology solutions
- PumpTrac™ remote pump monitoring and diagnostic services
- Instruction manual updates
- Training courses

**Flowserve... Supporting Our Customers
With The World's Leading
Pump Brands**



USA and Canada

Flowserve Corporation
Pump Division
Millennium Center
222 Las Colinas Blvd., 15th Floor
Irving, Texas 75039-5421 USA
Telephone: 1 972 443 6500
Telefax: 1 972 443 6800

Europe, Middle East, Africa

Worthington S.P.A.
Flowserve Corporation
Via Rossini 90/92
20033 Desio (Milan), Italy
Telephone: 39 0362 6121
Telefax: 39 0362 303396



Pump Division

Your local Flowserve representative:

**To find your local Flowserve representative
please use the Sales Support Locator System
found at www.flowserve.com**

Or call toll free: 1 800 728 PUMP

Latin America and Caribbean

Flowserve Corporation
Pump Division
6840 Wynnwood Lane
Houston, Texas 77008 USA
Telephone: 1 713 803 4434
Telefax: 1 713 803 4497

Asia Pacific

Flowserve Pte. Ltd.
Pump Division
200 Pandan Loop #06-03/04
Pantech 21
Singapore 128388
Telephone: 65 6775 3003
Telefax: 65 6779 4607